

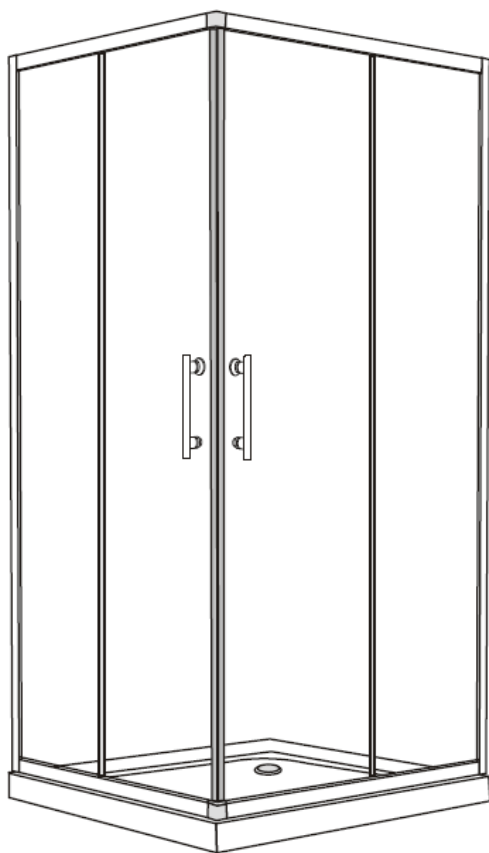

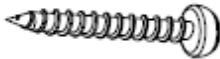







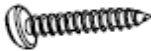

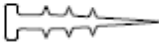

Инструкция к душевому уголку [Niagara NG-009-14QT](#)
[NIAGARA.SU](#) - Продажа, доставка, монтаж
8(800) 511-48-74

NG-008,009,010,012-14



1		ST4X30	X8
2		Φ6x30	X8
3		ST3. 5x25	X8
4		ST4X12	X10
5		ST4X12	X12
6			X4
7			
8			X8
9			X4
10			X2
11			X2
12			X2
13			X8
14			X2
15			X2

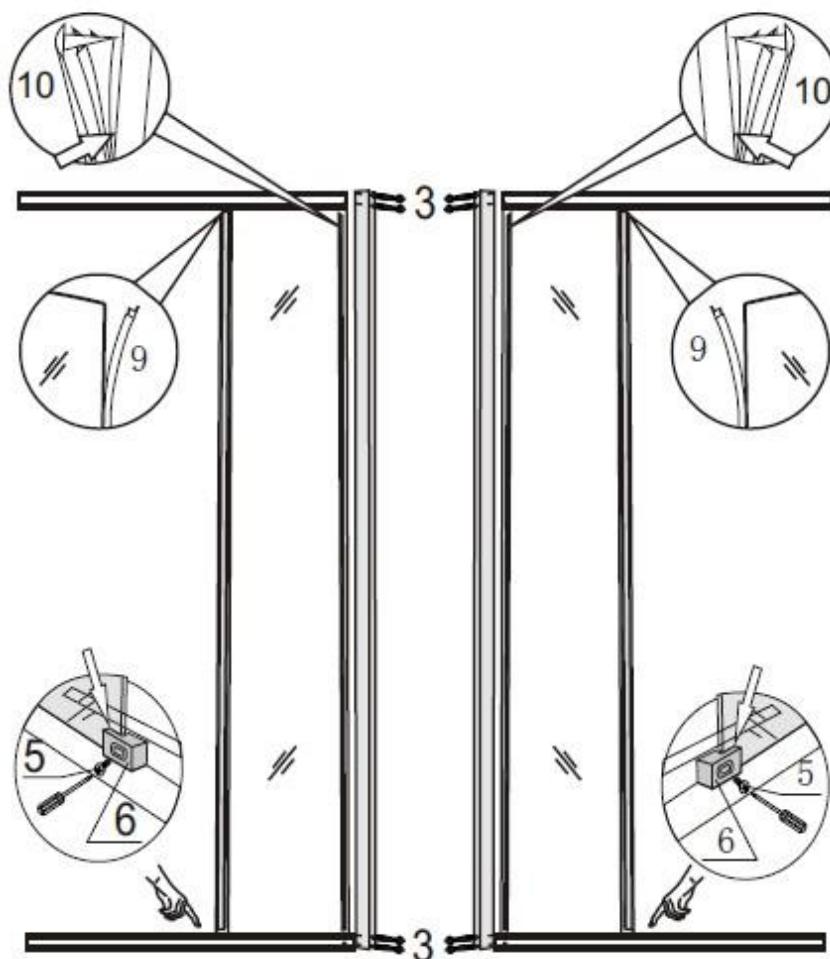
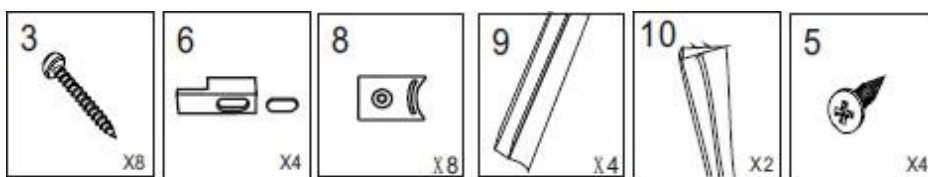

2

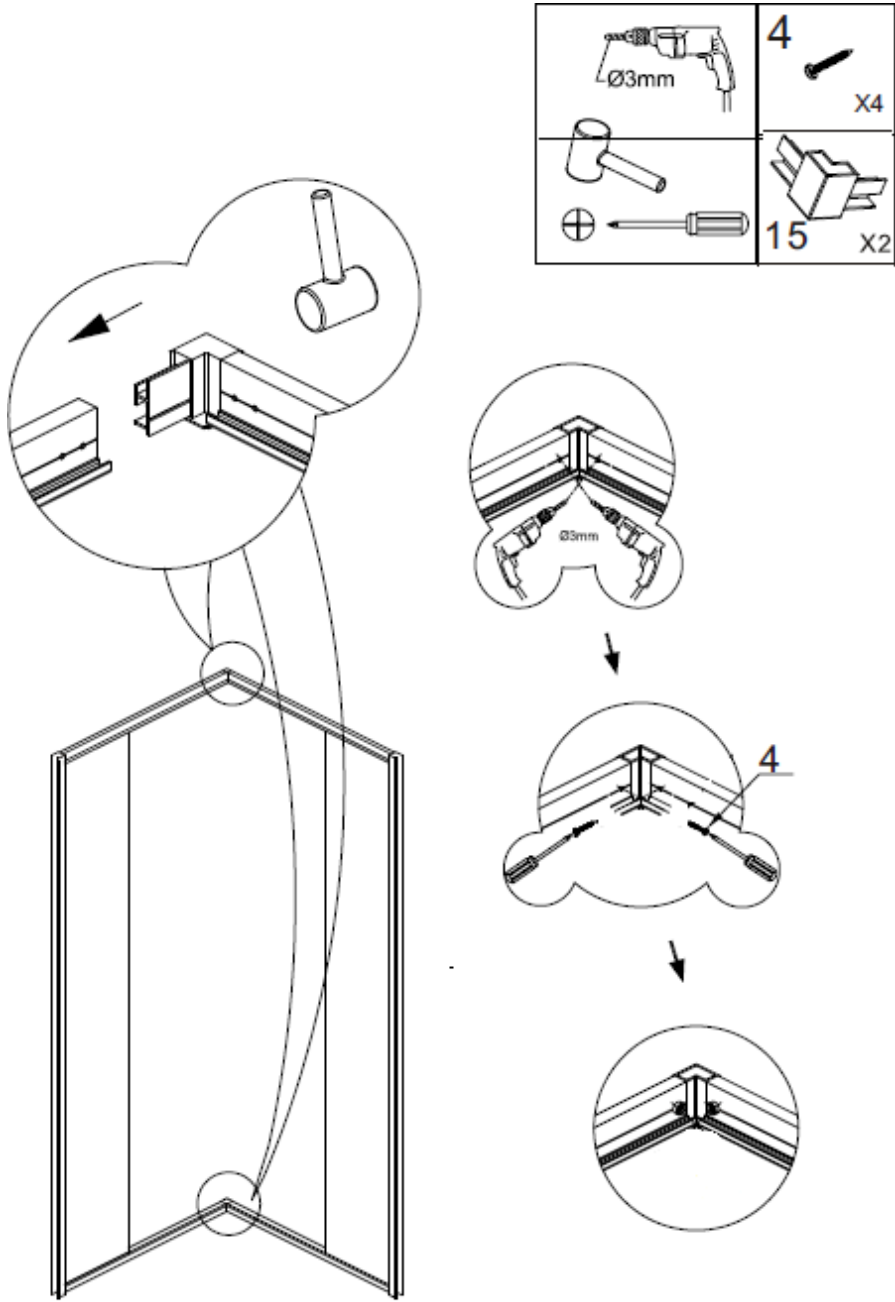

3

